

CZ0878/211

B

描述 Descriptions

防爆灯外壳由铝合金压铸成型，表面喷涂纯环氧树脂粉末，抗腐蚀性能好。透明罩采用钢化玻璃，外露紧固件采用不锈钢材料。防爆泛光灯的接线盒从下面进线，适用于橡胶套和铠装电缆布线，内部接线端子选用菲尼克斯国际认证笼式端子，便于接线。

防爆灯具内装 LED 颗粒，经专业的光学配光设计构成三种配光：宽光型、窄光型、标准型，灯具散热结构经专业的热学分析及特制铝基板导热结构，确保灯具工作时所产生的热量能很好的散热。满足石化、化学和海上工业照明的相关要求。

防爆灯采用手提移动式安装，手提移动式安装配自带二次夹紧装置的电缆密封套，防止现场移动拉扯电缆，从而导致电缆松脱现象发生。

- 长寿命免维护，使用寿命长达50000小时，可实现长期免维护
- 具有良好的电磁兼容性，不会对系统电网造成干扰
- 宽电压设计，电压波动无影响
- LED属于固态光源，抗震性能佳
- 安装维护方便
- 防护等级高达IP66
- IECEx 国际认证，ATEX 欧洲认证

The explosion-proof lamp shell is made of aluminum alloy die-casting, and the surface is sprayed with pure epoxy resin powder, with good corrosion resistance. The transparent cover is made of tempered glass, and the exposed fasteners are made of stainless steel. The junction box of explosion-proof floodlight is wired from below, which is suitable for rubber sleeve and armored cable wiring. The internal wiring terminal adopts Phoenix International Certified cage terminal for easy wiring.

The explosion-proof lamps are equipped with LED particles, and three kinds of light distribution are formed through professional optical light distribution design: wide light type, narrow light type, standard type. The heat dissipation structure of the lamps is designed through professional thermal analysis and special aluminum substrate heat conduction structure to ensure that the heat generated during the operation of the lamps can be well dissipated. It can meet the relevant requirements of petrochemical, chemical and offshore industrial lighting.

The explosion-proof lamp adopts bracket installation or portable mobile installation. The portable mobile installation is equipped with a cable sealing sleeve with secondary clamping device to prevent the cable from being pulled and loosened on site.

- It is long life and maintenance-free which the service life is up to 50000 hours and the maintenance-free of long term.
- There is a feature of good electromagnetic compatibility and it does not cause interference to the system power grid.
- It is not influenced by the voltage fluctuations and can be operated in the wide voltage range
- There is a good performance of vibration due to the LED is the solid-state light source.
- It is convenient to be mounted and maintained.
- The degree of protection is up to IP66.
- International IECEx Approval, Europe union ATEX Approval.

1 区和 2 区

21 区和 22 区

Zone 1 and zone 2

Zone 21 and zone 22

配光曲线 Luminous intensity distribution curve — C0/180 — C90/270

光强单位 luminous intensity unit: cd

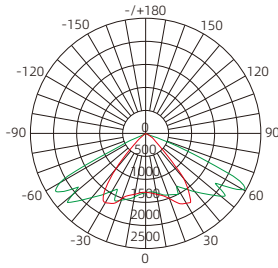
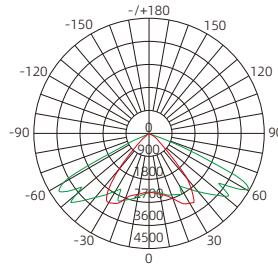
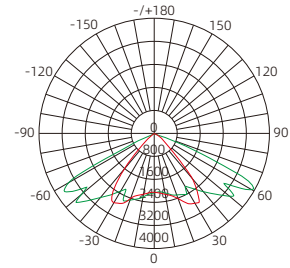
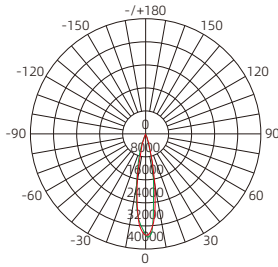
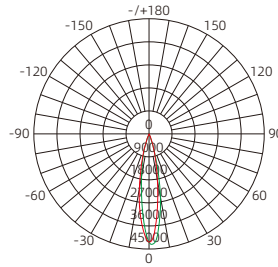
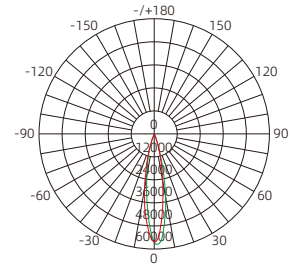
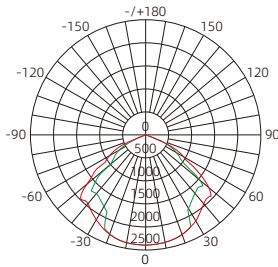
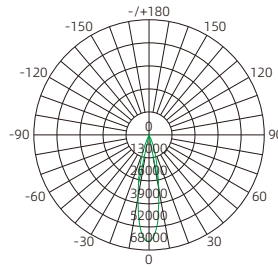
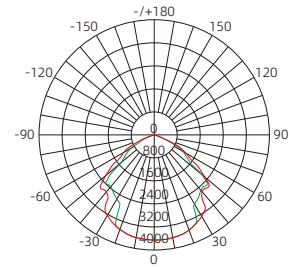
CZ0878/211 防爆LED泛光灯 (宽光型) Explosion-proof floodlight light fittings (wide beam)

 平均光束角 (50%) : 110.0度
 The average beam angle (50%) : 110.0 Degree
CZ0878/211 □-LED0060WWB

 平均光束角 (50%) : 105.5度
 The average beam angle (50%) : 105.5 Degree
CZ0878/211 □-LED0075WWB

 平均光束角 (50%) : 106.6度
 The average beam angle (50%) : 106.6 Degree
CZ0878/211 □-LED0090WWB
CZ0878/211 防爆LED泛光灯 (窄光型) Explosion-proof floodlight light fittings (narrow beam)

 平均光束角 (50%) : 20.1度
 The average beam angle (50%) : 20.1 Degree
CZ0878/211 □-LED0060WNB

 平均光束角 (50%) : 20.0度
 The average beam angle (50%) : 20.0 Degree
CZ0878/211 □-LED0075WNB

 平均光束角 (50%) : 19.2度
 The average beam angle (50%) : 19.2 Degree
CZ0878/211 □-LED0090WNB
CZ0878/211 防爆LED泛光灯 (标准型) Explosion-proof floodlight light fittings (Standard beam)

 平均光束角 (50%) : 106.2度
 The average beam angle (50%) : 106.2 Degree
CZ0878/211 □-LED0060W 1

 平均光束角 (50%) : 22.9度
 The average beam angle (50%) : 22.9 Degree
CZ0878/211 □-LED0075W 1

 平均光束角 (50%) : 105.0度
 The average beam angle (50%) : 105.0 Degree
CZ0878/211 □-LED0090W 1
B

主要数据 Main technical data

认证 Certification	防爆标志 Ex mark	符合标准 Meet the standard
China	Ex db eb IIB+H ₂ T5/T6 Gb Ex tb IIIC T70°C/T80°C/T85°C/T95°C Db	GB/T3836
IECEX	Ex db eb IIB+H ₂ T5/T6 Gb Ex tb IIIC T70°C/T80°C/T85°C/T95°C Db	IEC60079
ATEX	Ex II 2GD Ex db eb IIB+H ₂ T5/T6 Gb Ex tb IIIC T70°C/T80°C/T85°C/T95°C Db	EN60079

适用范围：用于 1 区和 2 区

用于 21 区和 22 区

使用环境温度：-40°C≤Ta≤+40°C/+55°C

-55°C≤Ta≤+40°C/+55°C

(-55°C灯具电气设备需要定制)

防护等级：IP66

额定电压：100V~240V AC 50/60Hz

光源：LED

色温：标配5000K、(可选3000K、4000K、6500K)

功率因数：≥0.95

接线端子：L1、N 笼式端子 2×1~2.5mm²，PE 端子 2×2.5~6mm²

电缆入口：1-M25×1.5 电缆密封套

1-M25×1.5 空塞堵头

符合：CE 2460

Intended use: Can be used in zone 1 and zone 2

Can be used in zone 21 and zone 22

Ambient temperature: -40°C≤Ta≤+40°C/+55°C

-55°C≤Ta≤+40°C/+55°C

(-55°C lamp electrical equipment need to be customized)

Degree of protection: IP66

Rated voltage: 100V~240V AC 50/60Hz

Light source: LED

Colour temperature: Standard 5000K, (Optional 3000K, 4000K, 6500K)

Power factor: ≥0.95

Terminal: L1, N cage type terminal 2×1~2.5mm², PE terminal: 2×2.5~6mm²

Cable entry: 1-M25×1.5 cable glands

1-M25×1.5 stopping plug

Conformity to: CE 2460

B

订购规格 Order specifications

图样 Illustration	配光 Light distribution	光通量 Luminous flux	功率 Power	温度组别T*				重量(kg) Weight	订购号 Order No.	
				Temperature class*						
				Ta≤40°C		Ta≤55°C				
气体 Gas	粉尘 Dust	气体 Gas	粉尘 Dust							
	宽光型 Wide beam	5244 lm	60W	T6	T70°C	T6	T85°C	8.8	CZ0878/211P-LED0060W WB5-17-□-DC1	
		6872 lm	75W	T6	T70°C	T5	T85°C	9.0	CZ0878/211P-LED0075W WB5-17-□-DC1	
		7594 lm	90W	T6	T80°C	T5	T90°C	9.3	CZ0878/211P-LED0090W WB5-17-□-DC1	
	窄光型 Narrow beam	6105 lm	60W	T6	T70°C	T6	T85°C	8.8	CZ0878/211P-LED0060W NB5-17-□-DC1	
		8674 lm	75W	T6	T70°C	T5	T85°C	9.0	CZ0878/211P-LED0075W NB5-17-□-DC1	
		9256 lm	90W	T6	T80°C	T5	T90°C	9.3	CZ0878/211P-LED0090W NB5-17-□-DC1	
	P-手提移动式安装 Portable mounting	标准型 Stadard beam	6059 lm	60W	T6	T70°C	T6	T85°C	8.8	CZ0878/211P-LED0060W 1 5-17-□-DC1
			7050 lm	75W	T6	T70°C	T5	T85°C	9.0	CZ0878/211P-LED0075W 1 5-17-□-DC1
			8747 lm	90W	T6	T80°C	T5	T90°C	9.3	CZ0878/211P-LED0090W 1 5-17-□-DC1

P-手提移动式安装 ← 灯具安装形式
Portable mounting ← The mounting ways of the light fittings

3-3000K
4-4000K
5-5000K
6-6500K } ← 色温
Colour temperature

2- -40°C≤Ta≤+40°C/+55°C
4- -55°C≤Ta≤+40°C/+55°C } ← 使用环境温度
Ambient temperature

电缆引入装置编码 Code of cable gland ←

电缆密封套引入编码 Code of cable gland

编码 Code	规格 Specifications	电缆直径 Cable diameter
DC1	铜制 1 个 CZ1725/1C M25×1.5 电缆密封套, 铜制 1 个 CZ1725/3A M25×1.5 空塞堵头 One brass CZ1725/1C M25×1.5 cable gland, one brass CZ1725/3A M25×1.5 stopping plug	Φ12-19mm
DC2	铜制 2 个 CZ1725/1C M25×1.5 电缆密封套 Two brass CZ1725/1C M25×1.5 cable glands	Φ12-19mm

B
外形尺寸 Outline dimensions

单位 Unit: mm

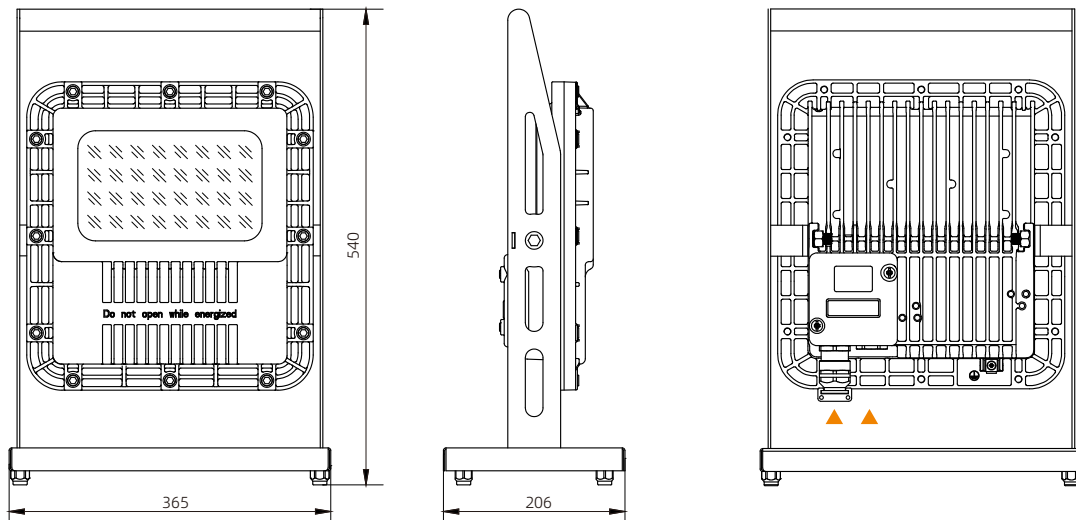
 移动式安装
 Mobile installation

► 电缆引入入口 Cable entry